

MODELS	DESCRIPTION
VSC2	Motorized ball valve, 2-way, DN 1/2"; Kvs 4 m ³ /h
VSC3	Motorized ball valve, 2-way, DN 3/4"; Kvs 6,3 m ³ /h
VSC4	Motorized ball valve, 2-way, DN 1"; Kvs 10 m ³ /h
VSC5	Motorized ball valve, 2-way, DN 1"1/4; Kvs 16 m ³ /h
VSC6	Motorized ball valve, 2-way, DN 1"1/2; Kvs 25 m ³ /h
VSC8	Motorized ball valve, 2-way, DN 2" Kvs 40 m ³ /h
VSC8-63	Motorized ball valve, 2-way, DN 2" Kvs 63 m ³ /h
VDC2	Motorized ball valve, 3-way, DN 1/2"; Kvs 4 m ³ /h
VDC3	Motorized ball valve, 3-way, DN 3/4"; Kvs 6,3 m ³ /h
VDC4	Motorized ball valve, 3-way, DN 1"; Kvs 10 m ³ /h
VDC5	Motorized ball valve, 3-way, DN 1"1/4; Kvs 16 m ³ /h
VDC6	Motorized ball valve, 3-way, DN 1"1/2; Kvs 25 m ³ /h
VDC8	Motorized ball valve, 3-way, DN 2"; Kvs 40 m ³ /h
VDC8-63	Motorized ball valve, 3-way, DN 2"; Kvs 63 m ³ /h

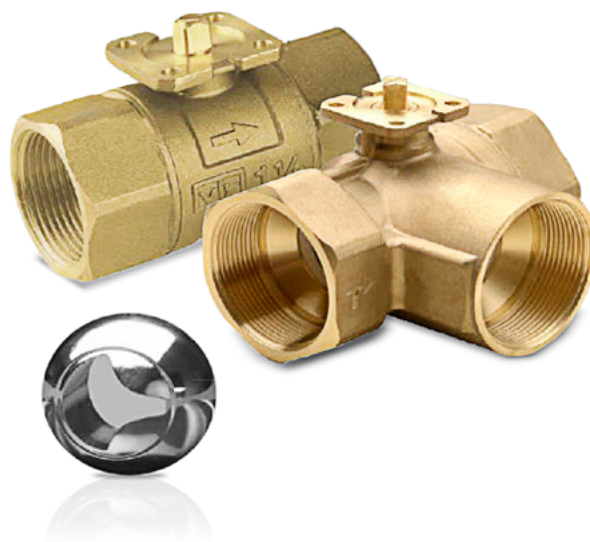

APPLICATION AND USE

For use in heating, ventilation, heating systems, and air conditioning systems.

Available in 2 and 3 way threaded connections, both provided with either modulating, on/off and 3p actuator (MVS216, MVS416, MV-S416F and MVSS16 with ISO 5211 F04 flange).

The substances admitted are belonging at the following categories:

- water, from -10°C to +130°C
- below 0°C only for water with antifreeze additive
- over 100°C only with additives that prevent boiling
- mixtures of ethylene glycol or propylene glycol > 20% and up to 50%

Not suitable for gas 1 and group 2, group 1 liquids (Dir. 2014/68/UE)

OPERATION

Characteristic curve

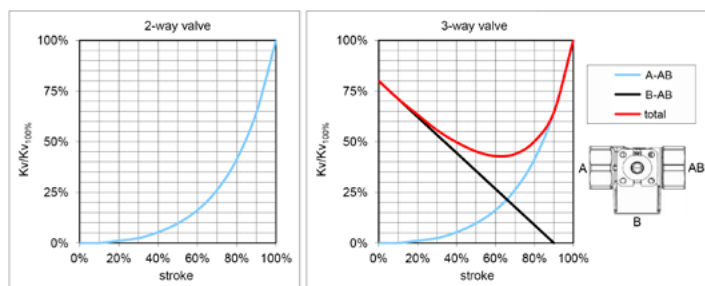

2-way valve

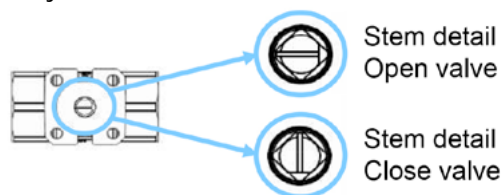

3-way valve

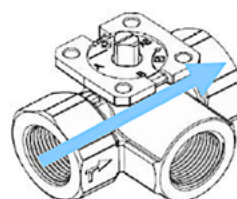
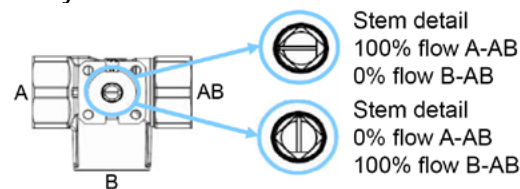

Flow A-AB

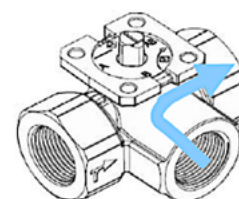

Flow B-AB

TECHNICAL CHARACTERISTICS

- Body:** PN 40
Construction: Pmax 16 bar
Materials: **Body** Brass (EN-12165 CW617N)
Seat PTFE
Ball Chrome plated Brass (EN-12164 CW617N)
Sealing leakage: Tight close-off
Connections: Female threaded
Actuator connection: ISO 5211 F04

TYPE	MODELS	DN	Kvs [m³/h]	THREADED	P max	ACTUATORS	FLUID TEMP.		ΔP
							MIN	MAX	
2-way	VSC2	1/2"	4	FF	16 bar	MVSx16 (16 Nm)	-10° C	+130° C	3,5 bar
	VSC3	3/4"	6,3	FF					
	VSC4	1"	10	FF					
	VSC5	1 ¼"	16	FF					
	VSC6	1 ½"	25	FF					
	VSC8	2"	40	FF					
	VSC8-63	2"	63	FF					
3-way	VDC2	1/2"	4	FFF					
	VDC3	3/4"	6,3	FFF					
	VDC4	1"	10	FFF					
	VDC5	1 ¼"	16	FFF					
	VDC6	1 ½"	25	FFF					
	VDC8	2"	40	FFF					
	VDC8-63	2"	63	FFF					

INSTALLATION RECOMMENDATIONS

Operating conditions

Temperature, nominal pressure and differential pressure on the valve must be within in the specified value.

Pipe Flushing

An anomalous valve flow action is caused, in almost all cases, by weld slag or foreign bodies entrapped between the valve seat and the

plug, often causing damages.

To prevent such inconveniences, it is advisable to use filters upstream of the valve.

Moreover, the pipelines must be thoroughly washed by positioning the valve stem at half stroke; this operation must be performed before start-up and after a prolonged shutdown of the system.

DIMENSIONS [mm]

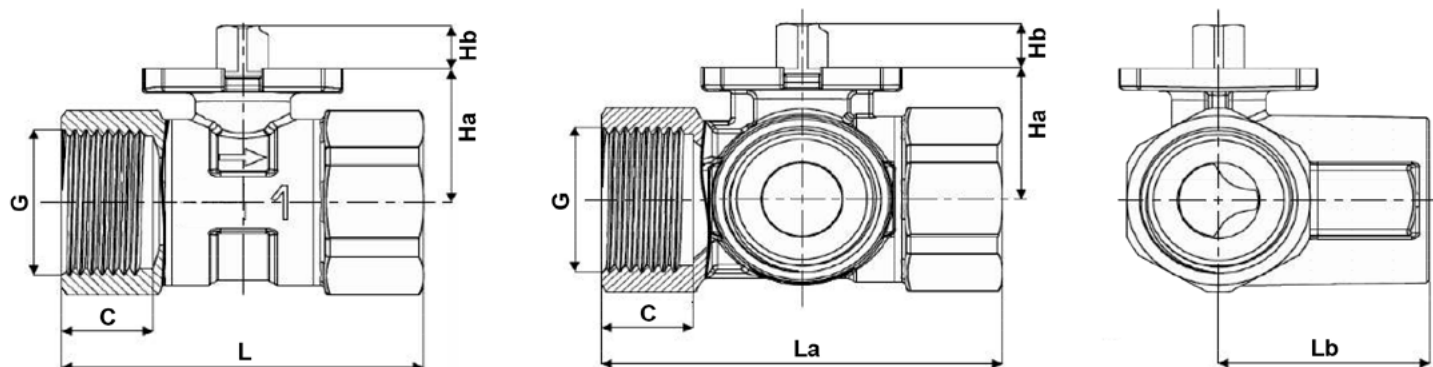

TYPE	MODELS	DN	G	L	La	Lb	C	Ha	Hb
2-way	VSC2	1/2"	1/2"	61,6	-	-	15,5	24,2	10
	VSC3	3/4"	3/4"	67,4	-	-	16,5	27,6	10
	VSC4	1"	1"	76,8	-	-	19,5	30,5	10
	VSC5	1 ¼"	1" 1/4	88	-	-	21,5	34,3	10
	VSC6	1 ½"	1" 1/2	101,8	-	-	21,5	39,8	10
	VSC8	2"	2"	116,2	-	-	25	52,8	10
	VSC8-63	2"	2"	116,2	-	-	25	52,8	10
3-way	VDC2	1/2"	1/2"	-	66,6	34	15,5	24,2	10
	VDC3	3/4"	3/4"	-	72,2	36,7	16,5	27,6	10
	VDC4	1"	1"	-	85,4	44,8	19,5	30,5	10
	VDC5	1 ¼"	1" 1/4	-	99,2	52,6	21,5	34,3	10
	VDC6	1 ½"	1" 1/2	-	109,6	57,1	21,5	39,8	10
	VDC8	2"	2"	-	131,4	68,9	25	52,8	10
	VDC8-63	2"	2"	-	131,4	68,9	25	52,8	10

The performances stated in this sheet can be modified without any prior notice

Document non contractuel - Nous nous réservons la possibilité de faire évoluer les caractéristiques de nos produits sans préavis

Siège social Lyon / 9 rue de Catalogne - Parc des Pivoles - 69153 Décines Cedex / +33 (0)4 72 15 88 70 / contact@c2ai.com

Agence Île de France
paris@c2ai.com

Agence Est
mulhouse@c2ai.com

Agence Sud-Ouest
sudouest@c2ai.com

Service Export
export@c2ai.com



contact@c2ai.com



www.c2ai.com