

Model		DN	flow rate Kvs m ³ /h	Stroke [mm]
2 way	3 way			
VSB3	VMB3	3/4"	6,3	16,5
VSB4	VMB4	1"	10	
VSB5	VMB5	1"1/4	16	
VSB6	VMB6	1"1/2	22	
VSB8	VMB8	2"	30	
VSB8A	VMB8A		40	

APPLICATION AND USE

Two-way VSB and three-way VMB valves can be used either for control or fluid detection in air-conditioning, thermoventilation and heating plants, both environmental and industrial, and in machines for product thermal process.

Three-way valves should be used only as mixing valves; angle way should never be used for control purposes.

MANUFACTURING CHARACTERISTICS

The valve body is made of G25 cast iron. The plug is in brass with Contoured-type profile on direct way and V-port on angle way. The stem is in CrNi steel with threaded M8 end and female threaded connections. The stem packing is constituted by a EPDM O-ring with graphited teflon scraper rings.

NOTE: The valves are also available in the stainless steel plug version (profile and Kvs are the same of the brass plug). For further sales information, please contact our Sales Support.

TECHNICAL CHARACTERISTICS

Constructions:	PN1600
Control characteristics:	direct way equal-percentage angle way linear (VMB)
Leakage*:	direct way 0...0,03% of Kvs (VSB) angle way 0...2% of Kvs (VMB)
connections:	female threaded
stroke:	16,5mm (max 18,5)
Allowed fluids:	
- water:	max. temperature 150°C min. temperature -10 °C (in case of ice on stem and gasket, use the stem-heater, see actuators data sheets; is not applicable to V.B DN15 valves)
- saturated steam:	glycol added max 50% max. temperature 150 °C max. pressure 250kPa (absolute value)
weight:	see dimensions

* Leakage is measured according to the EN1349 standard.

ATTENTION: If V.B valves are assembled with MVB+spacer (MVBHT) the max. operating temperature is 140°C, while without spacer is 120°C. For other actuators the max. operating temperature is 150 °C.



INSTALLATION

Before valves are mounted, make sure that pipes are clean, free from welding slags, that are perfectly lined up with valve body and not subjected to vibrations.

The valve can be mounted in any position except upside-down (for MVH actuators see Fig. 3).

While assembling, respect the flow directions indicated by the letters located on the valve body (see Fig. 1 and 2) and the application schemes.

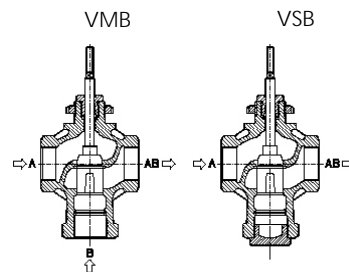

Fig. 1

Fig. 2

ACTUATORS

VSB and VMB are actuated by C2AI MVB, MVH, MVH56FA/C, MVE electrical actuators.

MOUNTING POSITIONS

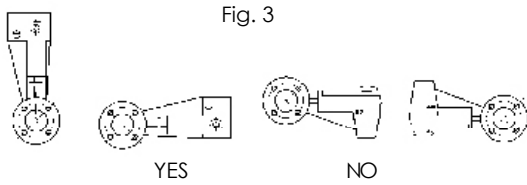

APPLICATION SCHEMES

VSB VALVES

a) Variable flow control when used

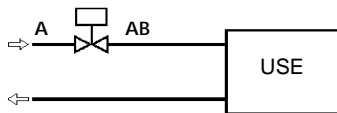

b) Constant flow when used in injection circuits

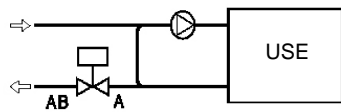

OPERATION

When stem is up, the direct way is closed, with stem down direct way is open.

ACCESSORIES

- AG52** Mounting kit for MVE actuator
- AG62** Mounting kit for MVH actuator
- AG63** Mounting kit for MVE..S actuator
- GVB3** Thermal insulation for DN 3/4" valves (V.B3)
- GVB4** Thermal insulation for DN 1" valves (V.B4)
- GVB5** Thermal insulation for DN 1 1/4" valves (V.B5)
- GVB6** Thermal insulation for DN 1 1/2" valves (V.B6)
- GVB8** Thermal insulation for DN 2" valves (V.B8)
- GVB8A** Thermal insulation for DN 2" valves (V.B8A)

VMB VALVES

c) Variable flow mixing when used

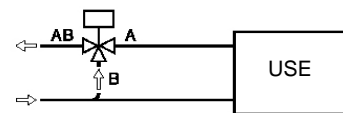

d) Constant flow mixing when used in injection or tapping circuits

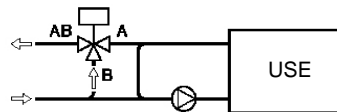

MAX DIFFERENTIAL CLOSE-OFF PRESSURE [kPa]

U-Bolt Connection	DN	MVH		MVHA/C*		MVB		MVE.06		MVE.10		MVE.15		MVE.22	
		A-AB	B-AB	A-AB	B-AB	A-AB	B-AB	A-AB	B-AB	A-AB	B-AB	A-AB	B-AB	A-AB	B-AB
VSB VMB	3/4"	1600	1600	1600	1560	1080	260	1600	1310	1600	1600	1600	1600	1600	1600
	1"	1600	1600	1380	1030	680	170	1190	870	1600	1560	1600	1600	1600	1600
	1 1/4"	1600	1370	840	650	410	110	720	540	1210	980	1600	1540	1600	1600
	1 1/2"	1170	990	590	470	290	80	500	390	860	710	1300	1110	1600	1600
	2"	870	750	440	350	210	60	370	290	640	540	960	840	1430	1263

100kPa = 1bar = 10m_{H₂O}

* with MVH.A in emergency valve closed, with MVH.C in emergency valve open.

MAX REGULATION DIFFERENTIAL PRESSURE [kPa]

The max regulation differential pressure, it means the pressure which can be used during the stroke, is conditioned by wear between seat and plug and by the performance guaranteed by the actuator for the evaluated valve. So we recommend not to overcome the differential pressure whose value corresponds to the minimum between 200kPa (maximum admitted value not to cause wear) and the one shown in the previous table (max close-off differential pressure).

Note: The max operating pressures at different temperatures for various PN classes must correspond to the following standards: UNI 1092-02 and UNI 12516-1.

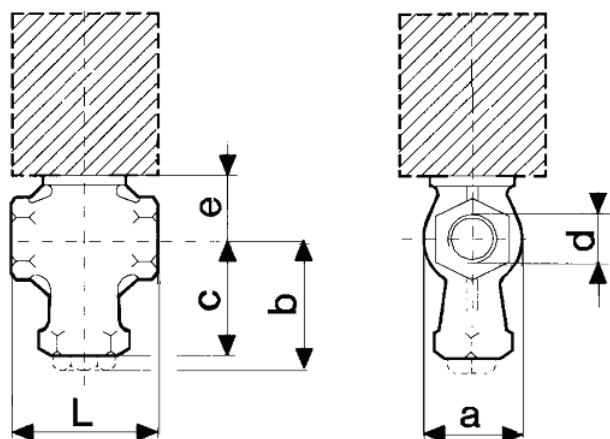

Valve dimensions [mm]							
DN	d	VSB-VMB			VSB	VMB	Weight [kg]
		L	a	e	b	c	
3/4"	G 3/4	85	54	34,5	79	67,5	1,1
1"	G 1/2	95	62	39,5	83	72,5	1,5
1"1/4	G 1"1/4	108	70	43,5	90	78,5	2
1"1/2	G 1"1/2	120	81	51	98	85,5	2,7
2" (V.B8A)	G 2"	194	97	54,5	111	97	5
2" (V.B8)	G 2"	142	97	54,5	111	97	4

The performances stated in this sheet can be modified without any prior notice