



- 0/4..20 mA or 0/2..10 V output signal
- 2 x programmable switches (push-pull)
- Backlit graphical LCD display (transreflective), can be read in sunlight and in the dark
- Programmable parameters via rotatable, removable ring (programming protection)
- All metal housing with scratch and chemical resistant glass
- Unit is displayed (selectable)
- Rotatable electronic head for best reading position
- Parameter interface

### Characteristics

The electronics can be used on the spot to set switching values where process values are exceeded or fallen short of. This setting can be carried out via the display even without a process. The present values or error messages from the measuring point are visible at any time, and all major parameters can be accessed on the spot. The analog current signal can be evaluated from large distances, and the present values can be made available there. If desired, the sensor can be configured at the factory with your parameters. It is therefore ready for immediate use, without programming. If you wish to change parameters, you can set the device directly at the sensor, by means of the programming ring.

The entire family of OMNI sensors is made up in a modular way, by means of a building-block system (hardware and software). A 16-bit microcontroller with a 14-bit A/D converter and a 12-bit D/A converter ensure the necessary processing speed and accuracy. The signal is displayed with the unit of measure by a backlit LCD graphical display, and is converted into a 0/4 – 20 mA signal. Two switching values with a choice of PNP or NPN output can be programmed across the whole range. The hysteresis of the switching values can be set separately in value and direction (min., max. switching value).

Exceeding or falling short of switching values, and error messages, are indicated by a flashing red LED visible from a long distance, together with a message in the display.

Further parameters can be modified by means of a code:

Signal filter, selectable unit (l/min, m<sup>3</sup>/h, etc.) incl. automatic conversion of the values, selectable output 0..20 mA, 4.0..20 mA, 0..10 V or 2..10 V, value assignment of 0/4..20 mA or 0/2..10 V (setting of zero point and range).

For commissioning, the sensor supports a simulation mode for the analog output. It is possible to create a programmable mA value at the output (without modifying the process variable). The range is 0..20 mA. This allows the wiring run between the sensor and the downstream electronics to be tested during commissioning.

The complete housing can be rotated around the mechanical connection, and so after sealing, the correct position for reading can be set. Operation is through dialog with the display messages. It is possible to reset to the factory settings at any time.

### Technical data

<b>Sensor</b>	Analog Hall sensor	
<b>Nominal width</b>	DN 8..25	
<b>Process connection</b>	Female thread G $\frac{1}{2}$ . G 1 (further process connections available on request)	
<b>Metering range</b>	0.1..80 l/min	For details see table "Ranges"
<b>Pressure loss</b>	0.4..1.6 bar at Q <sub>max.</sub>	
<b>Q<sub>max.</sub></b>	to 100 l/min	
<b>Tolerance</b>	±3 % of full scale value	
<b>Pressure resistance</b>	PN 200 optionally PN 500 bar	
<b>Medium temperature</b>	-20..+85 °C optionally -20..+150 °C	
<b>Ambient temperature</b>	-20..+70 °C	
<b>Media</b>	Water, oils (Gases and aggressive media available on request)	
<b>Wiring</b>	see section "Wiring"	
<b>Power supply</b>	18..30 V DC	
<b>Power requirement</b>	< 1 W	
<b>Analogue output</b>	0/4..20 mA, 0/2..10 V via a 500 W resistance after 0 V.	
<b>Switching values S1 + S2</b>	PNP or NPN, selectable, 300 mA max. load in total, programmable as min. value or max. value, resistant to short circuits, reversed polarity protected.	
<b>Display</b>	graphical LCD display, extended temperature range -20..+70 °C, 32 x 16 pixels, Backlite, displays value and unit, flashing LED signal lamp with simultaneous message on the display.	
<b>Ingress protection</b>	IP 67	
<b>Electrical connection</b>	For round plug connector M12x1, 5-pole	
<b>Materials medium-contact</b>	Brass construction: CW614N nickelled, CW614N, 1.4310, hard ferrite, NBR	Stainless steel construction: 1.4571, 1.4404, 1.4310, hard ferrite PTFE-coated, FKM
<b>Materials, non-medium-contact</b>	CW614N, PPS, glass	
<b>Weight</b>	see table "Dimensions and weights"	
<b>Installation location</b>	Standard: horizontal inwards flow; other installation positions are possible; the installation position affects the display, metering and switching range.	

## Signal output characteristic curves

Value x = beginning of the specified metering range

 = not specified range

Current output

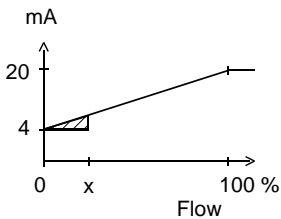

Voltage output

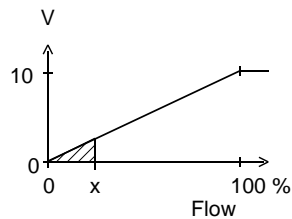

Other characteristic curves on request

## Ranges

Details in the table correspond to horizontal inwards flow with increasing flow rate.

Metering range l/min H <sub>2</sub> O	Q <sub>max.</sub> recom- mended	Pressure loss bar at Q <sub>max.</sub> H <sub>2</sub> O
0.1 - 1	6	0,4
0.5 - 5	10	0,5
1.0 - 10	20	0,6
2.0 - 20	30	0,4
3.0 - 30	40	
4.0 - 40	60	0,8
6.0 - 60	80	1,4
20.0 - 80	100	1,6

Special ranges are available.

## Wiring

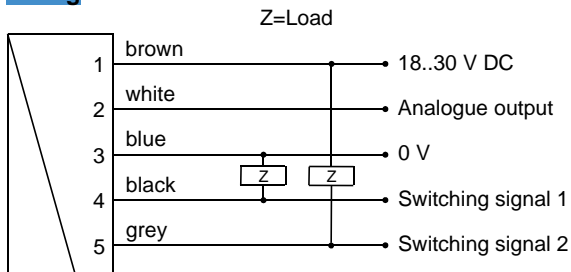

Connection example: PNP NPN

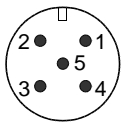

Plug connector M12x1

## Dimensions and weights

	G	Types	SW	X	Weight kg
Brass	G 1/4	HD1K-008GM	40	15	1,6
	G 3/8	HD1K-010GM			
	G 1/2	HD1K-015GM		18	1,5
	G 3/4	HD1K-020GM			
	G 1	HD1K-025GM			
stainless steel	G 1/4	HD1K-008GK	41	15	1,6
	G 3/8	HD1K-010GK			
	G 1/2	HD1K-015GK		18	1,5
	G 3/4	HD1K-020GK			
	G 1	HD1K-025GK			

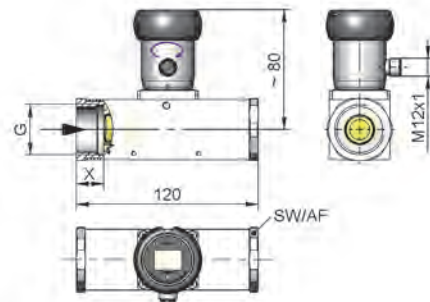

## Handling and operation

### Note

- Include straight calming section of 5 x DN in inlet and outlet
- Include a filter if the media are dirty (use magnetic filter for fer-ritic components)

## Programming

The annular gap of the programming ring can be turned to positions 1 and 2. The following actions are possible:



**Set to 1 = continue**  
**Set to 2 = modify (EDIT)**  
**Neutral position between 1 and 2**

The ring can be removed to act as a key, or turned through 180° and replaced to create a programming protector. Operation is by dialogue with the display messages, which makes its use very simple. Starting from the normal display (currently measured value with unit), if 1 (STEP) is repeatedly selected, then the display shows the following information in this order:

### Display of the parameters, using position 1

- Switching value S1 (switching point 1 in the selected unit)
- Switching characteristics of S1
- (MIN = monitoring of minimum value, hysteresis greater than switching value,
- MAX = monitoring of maximum value, hysteresis less than switching value)
- Hysteresis 1 (hysteresis value of S1 in the set unit)

- Switching value S2
- Switching characteristics of S2
- Hysteresis 2
- Code:  
After entering the code 111, further parameters can be defined:
- Filter (settling time of the display and output)
- Units: e.g. l/min or m<sup>3</sup>/h
- Output: 0..20 mA or 4..20 mA
- 0/4 mA (flow rate corresponding to 0/4 mA)
- 20 mA (flow rate corresponding to 20 mA)

#### Edit, using position 2

If the currently visible parameter is to be modified:

- Turn the annular gap to position 2, so that a flashing cursor appears which displays the position which can be modified.
- By repeatedly turning to position 2, values are increased; by turning to position 1, the next digit is reached.
- Leave the parameter by turning to position 1 (until the cursor leaves the row); this accepts the modification.
- If there is no action within 30 seconds, the device returns to the normal display range without accepting the modification.

The limit switches S1 and S2 can be used for the monitoring of minima or maxima.

With a minimum-switch, falling below the limit value causes a switchover to the alarm state. Return to the normal state occurs when the limit value plus the set hysteresis is once more exceeded.

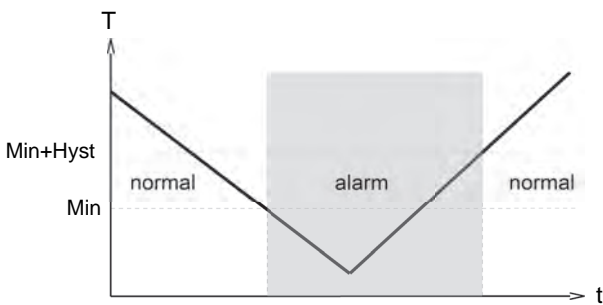

With a maximum-switch, exceeding the limit value causes a switchover to the alarm state. Return to the normal state occurs when the measured value once more falls below the limit value minus the set hysteresis.

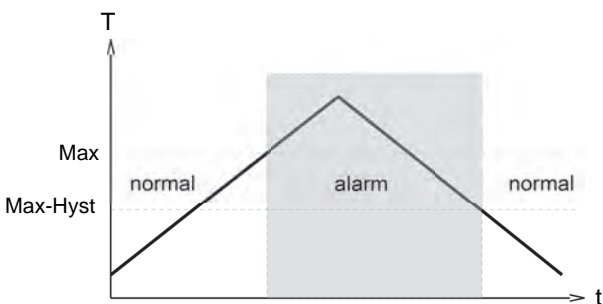

The change to the alarm state is indicated by the integrated red LED and a cleartext in the display. While in the normal state the switching outputs are at the level of the supply voltage; in the alarm state they are at 0 V, so that a wire break would also display as an alarm state at the signal receiver. Overload of the switching output is detected, indicated on the display ("Check S1 / S2"), and the switching output is switched off.

#### Simulation mode

To simplify commissioning, the sensor supports a simulation mode for the analog output. It is possible to create a programmable value in the range 0..21.0 mA (and/or 10 V) at the output (without modifying the process variable). This allows the wiring run between the sensor and the downstream electronics to be tested during commissioning. This mode is accessed by means of code 311.

#### Overload display

Overload of the switching output is detected, indicated on the display, and the switching output is set to high impedance.

#### Default setting

After setting the configuration parameters, they can be reset to factory values at any time, by means of code 989.

Starting from the normal display (currently measured value with unit), if 1 (STEP) is selected repeatedly, then the display shows the following information:

#### Display of the parameters, using position 1

- Switching values S1 and S2: Switching values in the selected unit.
- Hysteresis direction of S1 and S2:  
Max = hysteresis below S1 or S2  
Min = hysteresis above S1 or S2
- Hystereses Hyst 1 and Hyst 2:
- Hysteresis values of the switching values in the set unit
- After entering code S111, further parameters can be defined (this should take place only if necessary)
- Filter: Selectable filter constant in seconds (affects display and output)
- Units: e.g. bar or psi ...
- Output: 0..20 mA or 4..20 mA
- 0/4 mA: Displayed value for 0/4 mA
- 20 mA: Displayed value for 20 mA

#### Edit, using position 2

- If the **visible** parameter is to be modified:
- Turn the annular gap to position 2, so that a flashing cursor appears which displays the position which can be modified. By repeatedly turning to position 2, values are increased; by turning to position 1, the next digit is reached. In this way, every digit can be modified. If there is no action within 5 seconds, the device returns to the normal display range without accepting the modification.

#### Saving the changes using position 1

- After leaving the last value, turn once to position 1; this accepts the modification.

## Ordering code

The basic device is ordered e.g. HD1K-015GM005E with Evaluation electronics, e.g. OMNI-HD1K-S

HD -

OMNI-HD -

<b>1. Construction</b>	
1K	standard
<b>2. Nominal width</b>	
008	DN 8 - G 1/4
010	DN 10 - G 3/8
015	DN 15 - G 1/2
020	DN 20 - G 3/4
025	DN 25 - G 1
<b>3. Process connection</b>	
G	Female thread
<b>4. Connection material</b>	
M	Brass
K	stainless steel
<b>5. Display range H<sub>2</sub>O for horizontal inwards flow</b>	
001	0.1 - 1 l/min
005	0.5 - 5 l/min
010	1.0 - 10 l/min
020	2.0 - 20 l/min
030	3.0 - 30 l/min
040	4.0 - 40 l/min
060	6.0 - 60 l/min
080	20.0 - 80 l/min
<b>6. Connection for</b>	
E	Evaluation electronics
<b>7. For base device</b>	
1K	standard
<b>8. Analog output</b>	
I	current output 0/4..20 mA
U	voltage output 0/2..10 V
<b>9. Electrical connection</b>	
S	For round plug connector M12x1, 5-pole
<b>10. Options 1</b>	
H	<input type="radio"/> Model with gooseneck
O	<input type="radio"/> Tropical model with oil filling
D	<input type="radio"/> Spacer

## Options

- Tropical model (completely oil-filled for severe external applications or for rapidly changing temperatures. Reliably prevents condensation).
- Measured values for oil or gas
- Special quantities
- Version for 150 °C
- Temperature display 0..120 °C
- reinforced piston

## Accessories

- Round plug connector / cable (KB...)  
For additional information, refer to the main directory "Accessories"

## Ordering information

- Specify direction of flow, medium, and metering range.
- For viscous media specify viscosity, temperature and medium (e.g. ISO VG 68) (enquire about metering range).
- For gases, state pressure (relative or absolute), temperature and medium (e.g. air) (request metering range)